

# Blue Sky Bio Multi – unit Abutments

**BIO | Multi-Units are available for all our Bone Level Implants**

Multi-Units abutments are ideal for following restorative plans

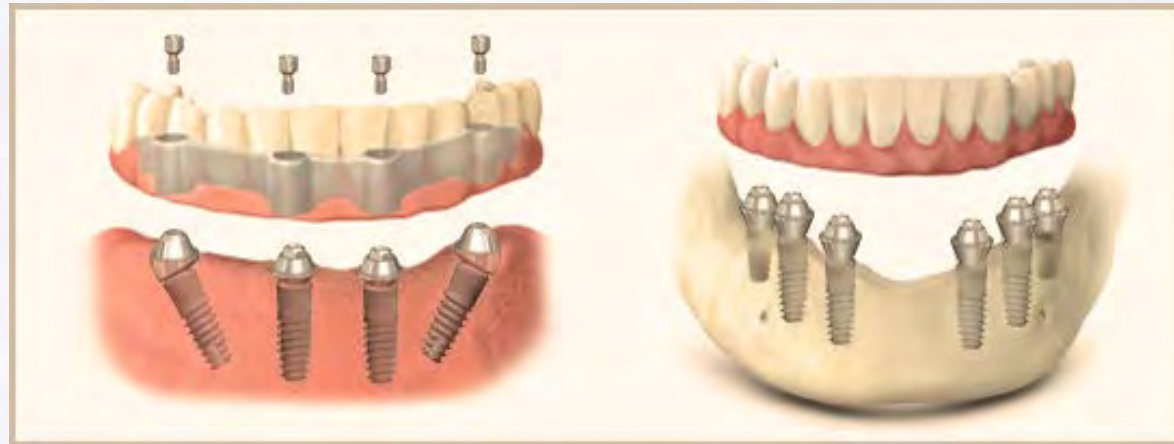

**Blue Sky Bio**



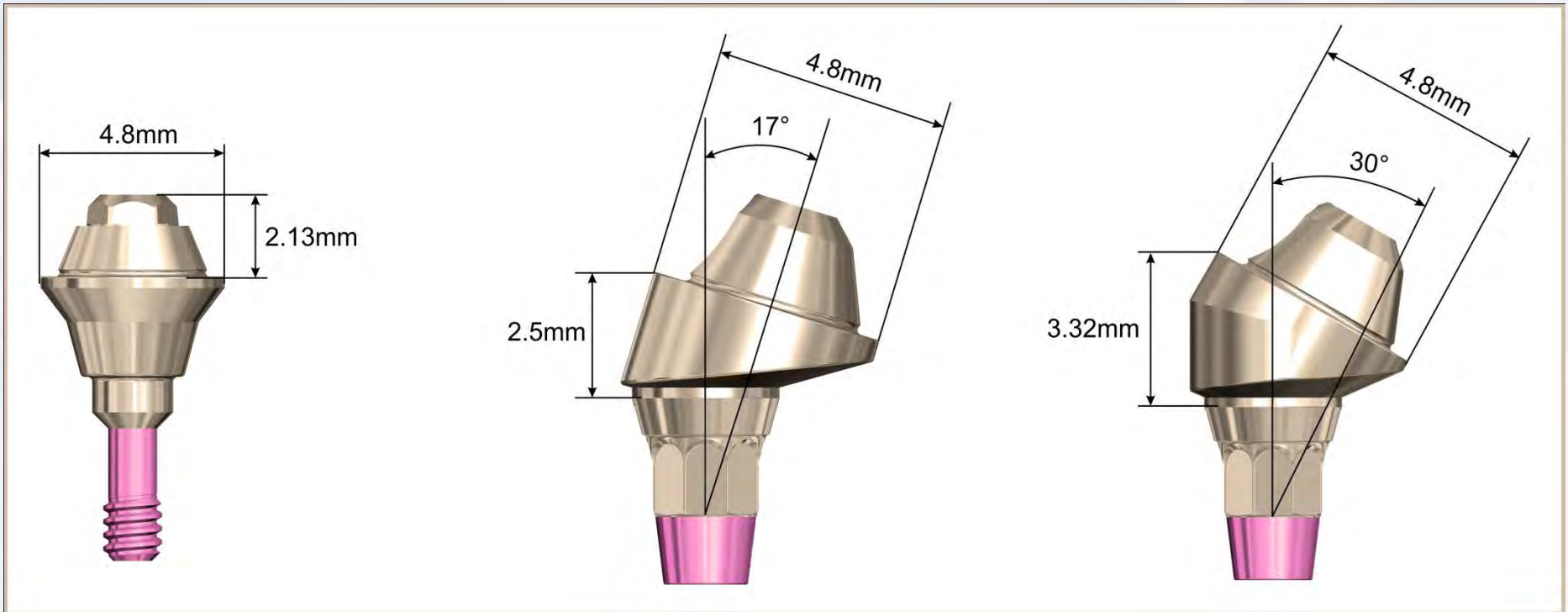

# Blue Sky Bio Multi – unit Abutments



Blue Sky Bio

# Blue Sky Bio Multi – unit Abutments

Components

| Size  | Part #                             |
|---|------------------------------------|
|    | CMU                                |
|    | MMUP<br><i>Requires screw SMUS</i> |
|    | MMUT<br><i>Requires screw SMUS</i> |
|   | BMU                                |
|  | DSMU                               |
|  | SMUL                               |
|  | SMUS                               |
|  | HFD                                |

Blue Sky Bio offers a variety of components that can be used with BIO | Multi-units.

NobelBiocare<sup>©</sup> Multi-Unit components can also be used.



Blue Sky Bio

# Blue Sky Bio Multi – unit Abutments

HFD



DMSU

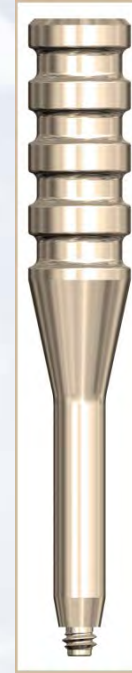

Use to torque Straight-unit abutments. Driven by 4mm square drive hand wrench, ratchet, or torque wrench. Do not exceed 30Ncm.

Use to carry angled BIO | Multiunit Abutments.



**Blue Sky Bio**

# Blue Sky Bio Multi – unit Abutments

## BIO | Multi-Unit Abutments Placement

Delivering Straight Multi-unit Abutments

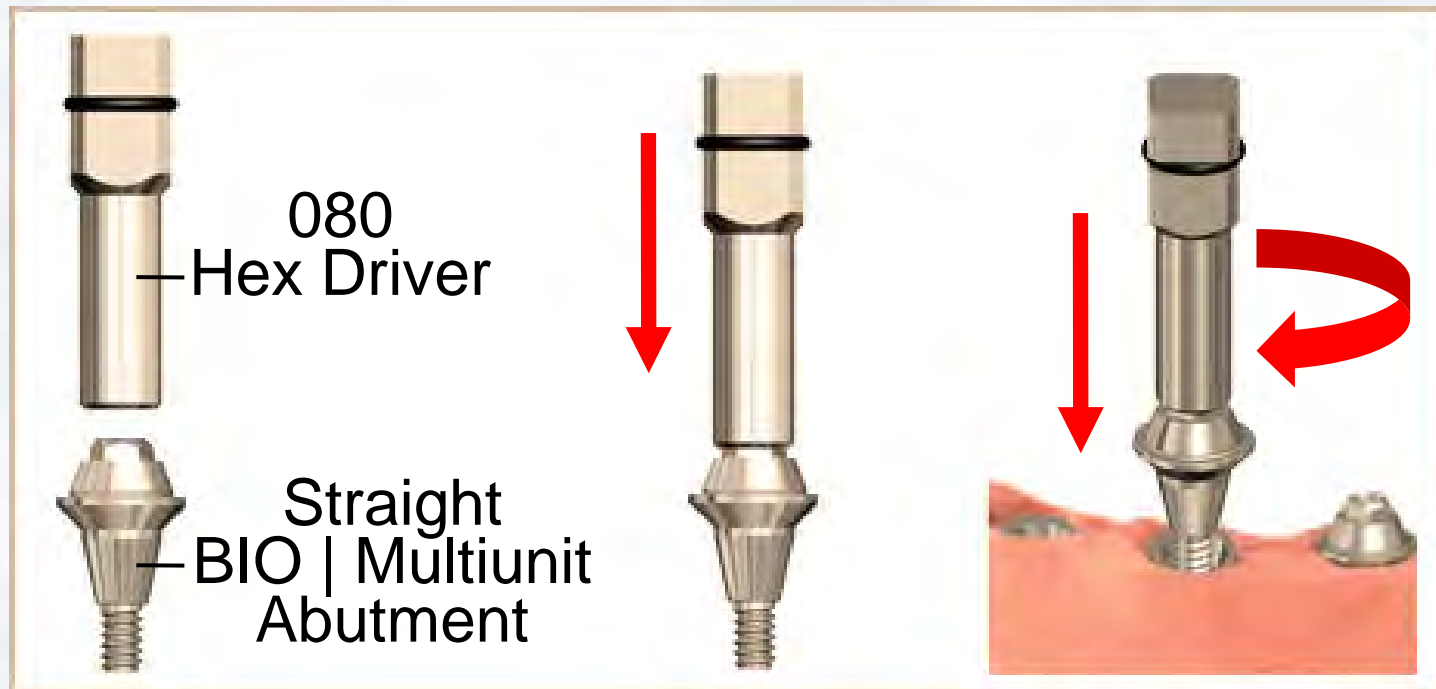

**Blue Sky Bio**

# Blue Sky Bio Multi – unit Abutments

## BIO | Multi-Unit Abutments Placement

Delivering Angled Multi-unit Abutments

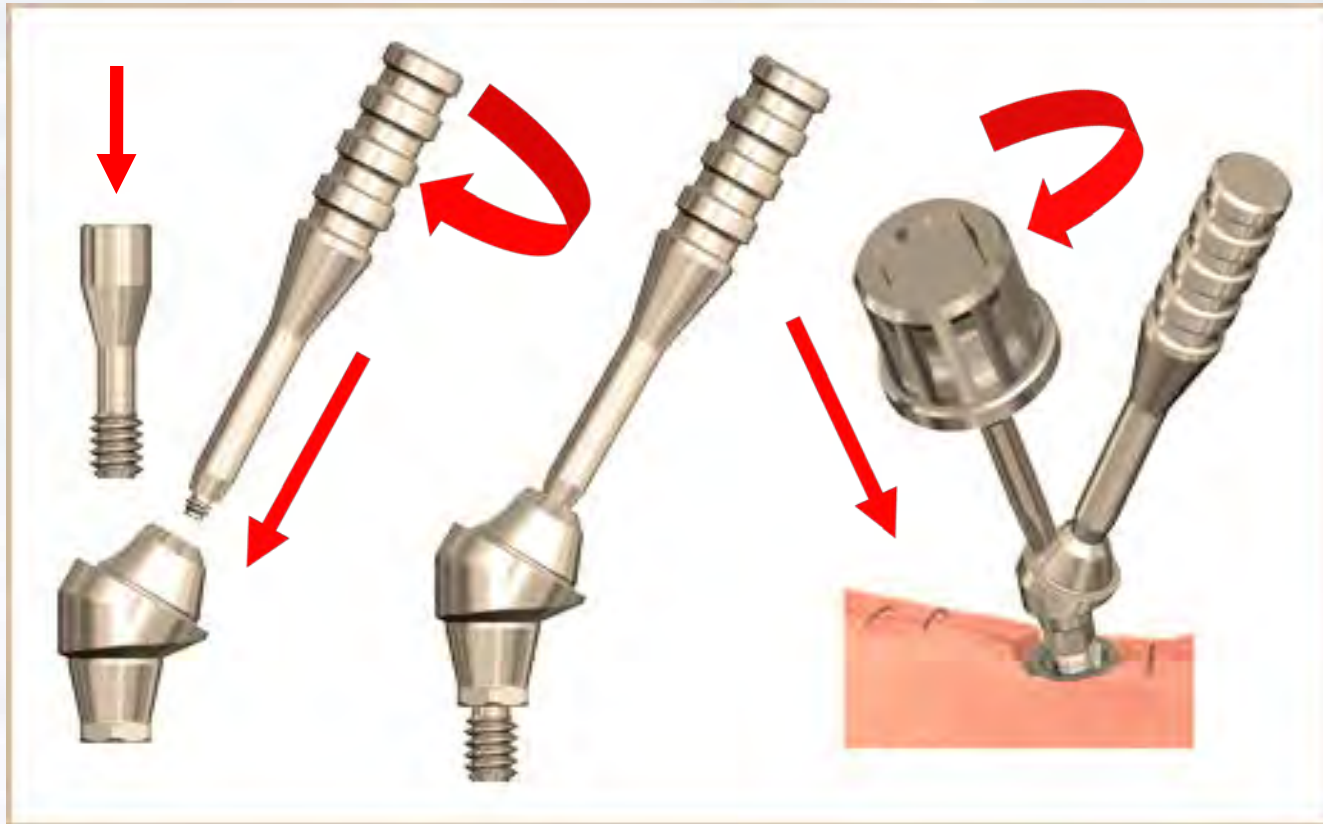

Blue Sky Bio

# Blue Sky Bio Multi – unit Abutments

## Immediate Load Steps

### Immediate Temporization



1. Select and seat the appropriate collar height multi-unit abutment. The margin should be 1 to 2 mm supragingival. Hand tighten with HFD during healing phase and then tighten with 30NCm after healing has occurred.



2. Place MMUT. Hand-tighten.

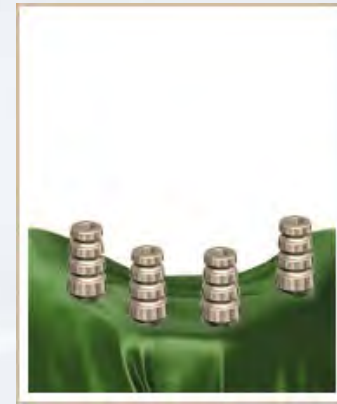

3. Place a sheet of rubber dam in the shape of an arch over all the temporary copings to protect the tissue during the acrylic phase.



**Blue Sky Bio**

# Blue Sky Bio Multi – unit Abutments

## Immediate Load Steps

### Immediate Temporization



4. Place holes in the denture to match the location of the temporary copings until the denture fully seats. Adjust height of the MMUT to allow for complete occlusion.

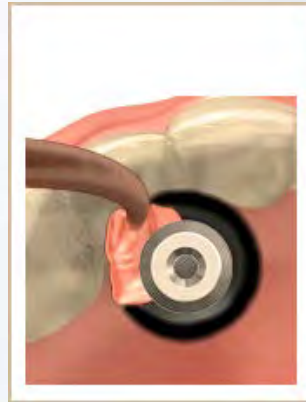

5. Use a flowable composite or acrylic to secure each coping to the denture while making sure to keep the screw – access holes free from composite.

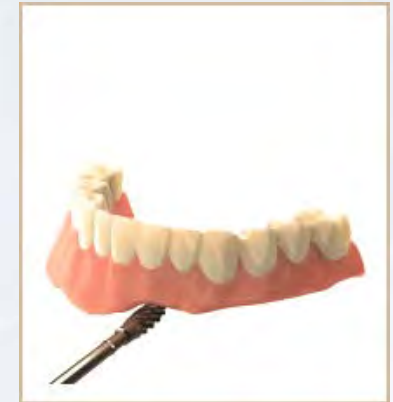

6. Disconnect the denture, remove the flanges and fill the voids with acrylic on the tissue side.



**Blue Sky Bio**



# Blue Sky Bio Multi – unit Abutments

## Deliver Denture

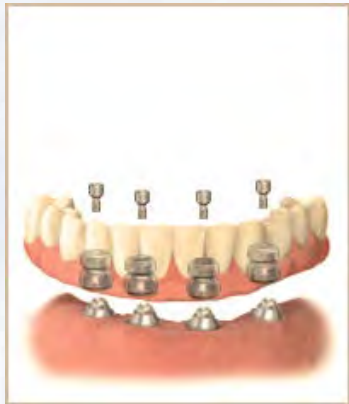

1. Place the all acrylic bridge on the Multi-unit abutments and torque the prosthetic screws to 15Ncm.

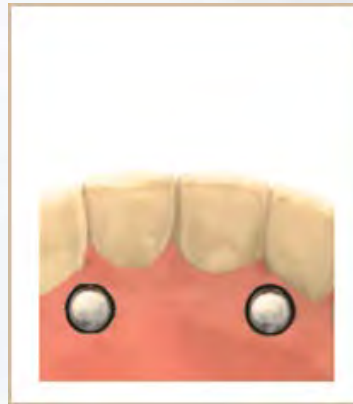

2. Fill in the screw-access holes with the material of choice. Check occlusion.

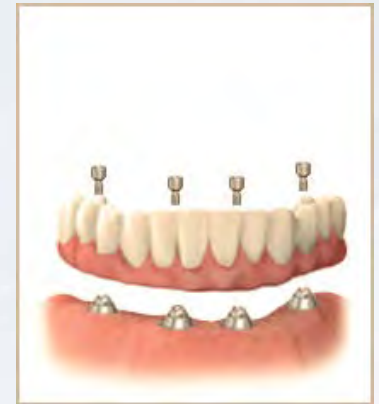

3. Follow conventional prosthetic procedures to fabricate the final restoration.



**Blue Sky Bio**

# Blue Sky Bio Multi – unit Abutments

Open Tray Impression Technique  
(closed tray not recommended)

MMUT titanium  
for impression,  
can be used for  
laser welded bar  
as well. Use long  
screw SMUL for  
impression.

MMUT



SMUL



Blue Sky Bio

# Blue Sky Bio Multi – unit Abutments

## Open Tray Impression Technique (closed tray not recommended)

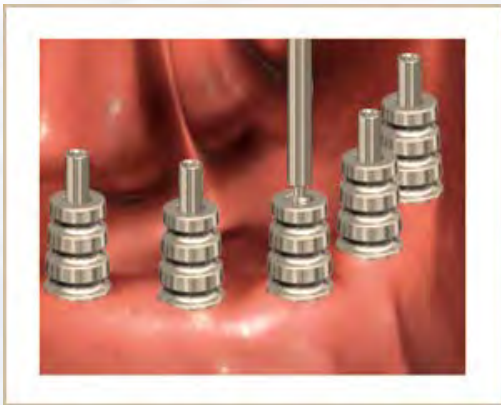

Place the Abutments. Hand-tighten.

Try in the impression tray to verify that the screws protrude through the openings without interference.

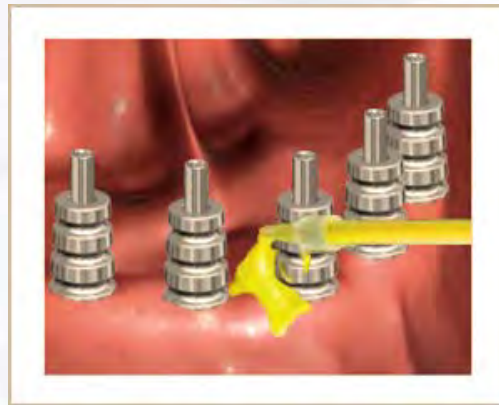

Syringe a medium or heavy-bodied impression material around the Impression Copings.



Load the custom impression tray with a medium or heavy-bodied impression material and seated in the mouth.

Wipe impression material off the top of the screws before sets. Allow the impression material to set.



# Blue Sky Bio

# Blue Sky Bio Multi – unit Abutments

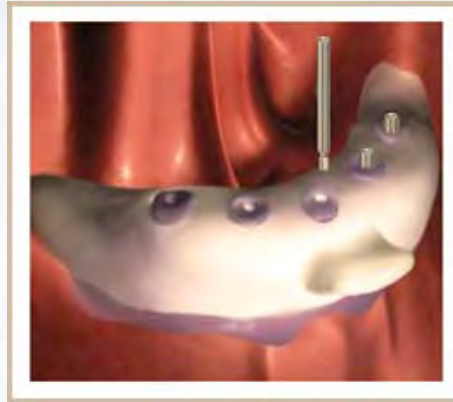

After the impression material has set, remove the long screw. Remove the impression from the mouth. Verify that the impression material is completely adapted around the copings. Place the Cover Caps on the Abutments for Screw and hand-tighten.



**Blue Sky Bio**

# Blue Sky Bio Multi – unit Abutments

**BMU** Multi-Unit Analog, works for both straight and angled.

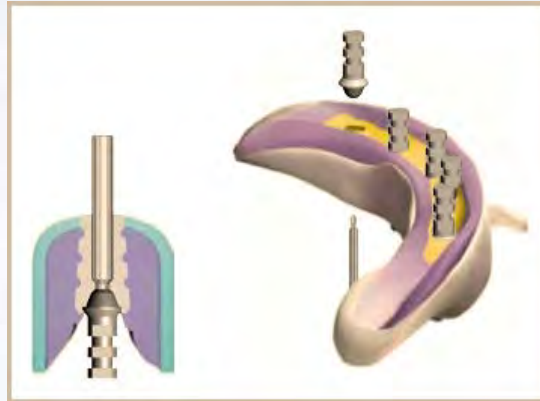

Place BMU Analogs onto the Transfer copings by holding the analog in place while inserting the long screws through the access holes in the impression tray. Hand-tighten the screw.

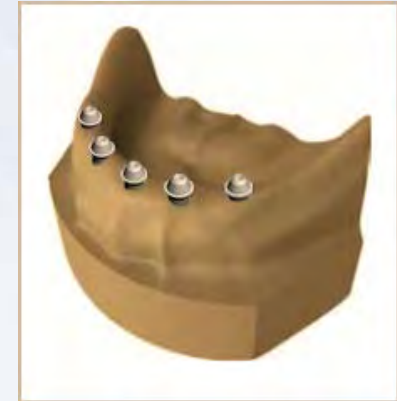

Fabricate a working cast. Articulate according to normal laboratory procedures.



**Blue Sky Bio**

# Blue Sky Bio Multi – unit Abutments

## Casting Technique



After casts have been mounted at the proper occlusal relationships attach MMUP burnout abutments with SMUS screws



Adjust and wax up MMUP



Blue Sky Bio

# Blue Sky Bio Multi – unit Abutments



Follow conventional prosthetic procedure to fabricate the final restoration .



**Blue Sky Bio**